

INSTALLATION MANUAL

versatile™ 4C Depot Stand-alone Cabinet



FLORENCE
≡ CORPORATION

5935 Corporate Drive • Manhattan, KS 66503
800 275 1747 • www.florencemailboxes.com

TABLE OF CONTENTS

GENERAL INFORMATION AND ADVISORIES2
ASSOCIATED TECHNICAL DOCUMENTS2
4C DEPOT OVERVIEW3
SUGGESTED TOOLS4
HARDWARE LIST5
UNPACK THE 4C DEPOT6
PREPARATION AND INITIAL PLACEMENT7
ANCHOR THE 4C DEPOT TO CONCRETE	11
FINISH INSTALLATION	12
4C MAILBOX ACTIVATION BY USPS	12
APPENDIX A: INSTALLING 4C MAILBOX INTO DEPOT CABINET	13

GENERAL INFORMATION AND ADVISORIES



ATTENTION!

CAUTION -- Transportation and Handling

- Florence 4C Depot units are heavy. Use caution when lifting and carrying to avoid injury.
- Lay boxes flat. Do not stand on end as box could fall over and cause injury.

CAUTION -- Installation

- Florence 4C units are heavy. Do not stand 4C units up without support to prevent tipping.
- Pinch hazard exists when placing cabinets next to each other. Keep fingers and hands clear to avoid injury.
- Florence 4C units are also front-heavy when the master doors are open. Units must be braced or held in place until secured to the concrete. Failure to do so could result in serious injury.

ASSOCIATED TECHNICAL DOCUMENTS

- ▶ 206362—4C Mailbox Installation Manual
- ▶ 206367—4C Mailbox Maintenance Manual
- ▶ 206731-001—4C Depot Stand-alone Cabinet Foundation Plan

4C DEPOT OVERVIEW

- The 4C Depot consists of a stand-alone cabinet with a 4C mailbox installed.
- 4C Depot cabinets are of aluminum construction with a durable powdercoat finish on all exposed exterior surfaces.
- Each Depot cabinet has four (4) adjustable leveling feet for installation on uneven surfaces.
- Each Depot cabinet has a removable lower-front panel to allow easy access for leveling and anchoring the cabinet to a concrete pad..

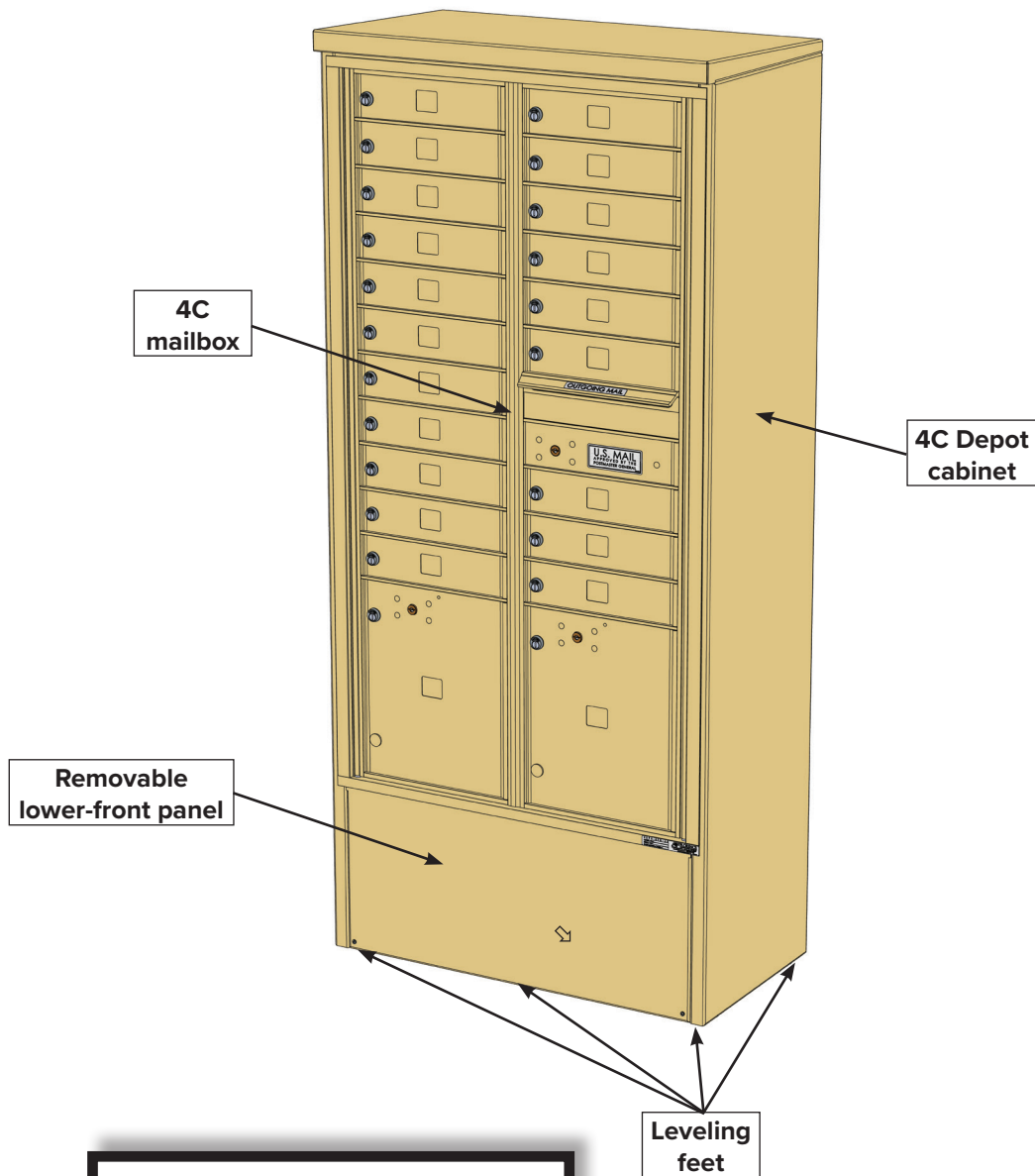

Each leveling foot has a 1-1/2" maximum adjustment range.

SUGGESTED TOOLS

Unloading/Unwrapping:

- Tin snips
- Dolly
- Straps

Basic Installation:

- 2-ft level
- Hammer drill
 - ▶ 7/16" masonry bit — >4" length required
- Cordless drill/driver w/clutch
- #2 Phillips driver bit
- SAE open end wrench or socket set (9/16" and 3/4" required)

General:

- Gloves
- Safety glasses
- Steel toed shoes
- Shop vacuum
- Broom
- Waterbased cleaner, such as "Simple Green™"
- Soft chamois

HARDWARE LIST

Plastic bag placed inside a compartment near the bottom of the 4C mailbox unit.

- If cabinet is shipped without a 4C module installed, package will be taped to the inside lower back of the 4C Depot cabinet prior to shipment.

K214164 hardware kit consisting of the following items is included:

(1) K214163 kit which contains:

(15) **206727** - 10-32 x 1/2", Phillips-head self-tapping screw, Stainless Steel

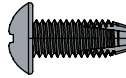

(1) **206729** - 11/64" diameter drill bit, HSS

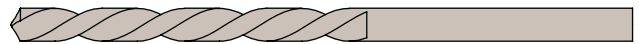

(1) **206730** - #2 square-tip 1/4" hex-shank insert driver bit, Steel

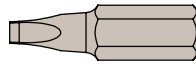

(4) **206725** - 1/2" x 3" hex-washer-head Tapcon® anchor bolt, Steel

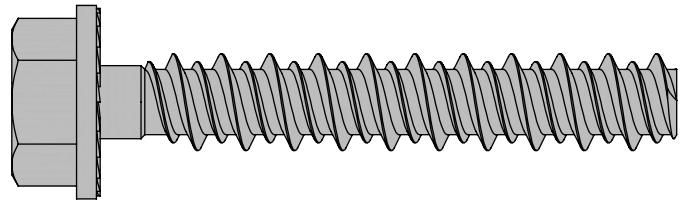

K65734 kit (included only with a 4C Depot with no 4C module installed) which contains:

(22) **65734** - 8-18 x 1 1/4" pan-head T20 Torx screws, zinc-plated Steel



Styrofoam-wrapped package taped to the inside lower back of the 4C Depot cabinet prior to shipment.

K214206 kit, included with single-wide cabinet, consisting of:

(2) **206719** - 4C Depot cabinet mounting bracket

(2) **206721** - 4C Depot cabinet single-wide skirt plate

OR

K214207 kit, included with double-wide cabinet, consisting of:

(2) **206719** - 4C Depot cabinet mounting bracket

(2) **206720** - 4C Depot cabinet double-wide skirt plate

UNPACK THE 4C DEPOT

IMPORTANT NOTE:

When accepting the shipment from the carrier, inspect, and make note of, and/or photograph, any noticeable damage that may have occurred during shipment. Report any damage found to the freight company.

If you have purchased a 4C Depot free-standing cabinet with no 4C mailbox installed, go to “APPENDIX A: INSTALLING 4C MAILBOX INTO DEPOT CABINET” on p. 13 for instructions to install your 4C mailbox into the cabinet.

1. Each 4C Depot, with 4C mailbox installed, will arrive packaged in a single cardboard carton held together by banding.

Be extremely careful not to scratch or damage the finish on the unit when removing the packaging.

2. Cut the banding and carefully remove the packaging from the 4C Depot.
3. A package containing the hardware needed to install the 4C cabinet is inside a compartment near the bottom of the 4C mailbox unit (refer to “**HARDWARE LIST**” on p. 5).
4. A package containing the 4C cabinet mounting brackets and skirt plates is taped to the inside lower back of the 4C Depot cabinet (refer to “**HARDWARE LIST**” on p. 5).
5. Ensure the leveling feet on the 4C Depot cabinet are adjusted up all the way.
6. Carefully move the 4C Depot to the installation/staging area.



WARNING: 4C Depot with 4C mailbox installed is heavy. Use two (2) or more people to move cabinets. Use caution when lifting and carrying. Failure to do so could result in serious injury.

PREPARATION AND INITIAL PLACEMENT

1. Place the 4C cabinet in the desired installation location.



2. Remove the lower-front panel from the cabinet.

- Use the #2 square-tip 1/4" hex-shank insert driver bit supplied in the package of hardware, placed into a cordless driver, to remove the two (2) screws from the panel.

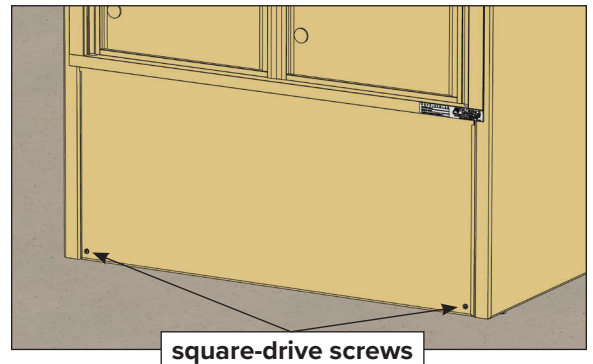

- Pull the panel out at the bottom and down from behind the 4C mailbox trim.

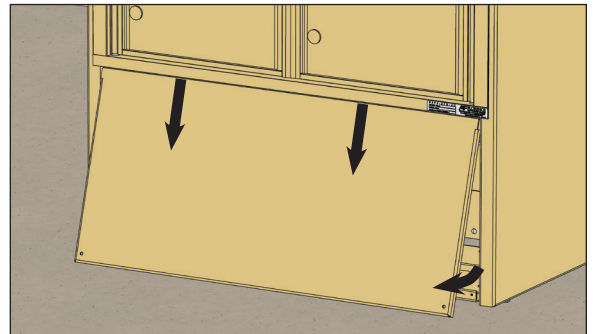

- 3.** Remove the styrofoam-wrapped package, taped to the inside lower back of the 4C Depot cabinet (containing two (2) mounting brackets and two (2) skirt plates), and set it aside for later installation.

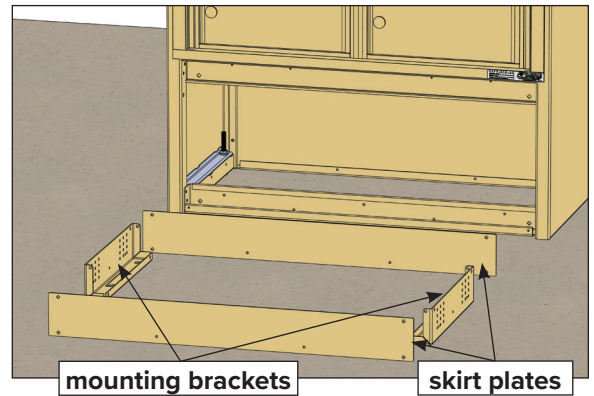

- 4.** Adjust the leveling bolts down with a 9/16" wrench until the unit is level.

Note: A 9/16" wrench is incorporated into each of the mounting brackets, if you need them. They can be removed by breaking the tabs holding them in place.

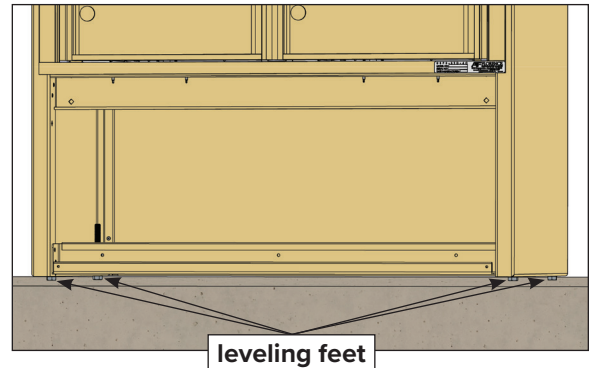
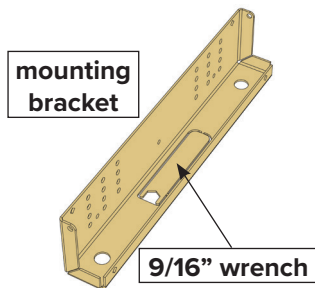

- You should only have to adjust 3 of the 4 leveling bolts. The leveling bolt that remains unadjusted is the leveling bolt located in the highest spot on the concrete slab.
- Each full turn on the adjusting-foot screw will raise or lower the corner of the module 1/16".
- Place a 2-ft level across the top, sides, and front and ensure the bubble is centered, indicating the cabinet is level and plumb. **Failure to do this properly will likely cause problems with the 4C mailbox operation.**

- 5.** Tighten the jam nuts on all four (4) of the leveling bolts with a 9/16" wrench to lock the leveling bolts in their leveled position.

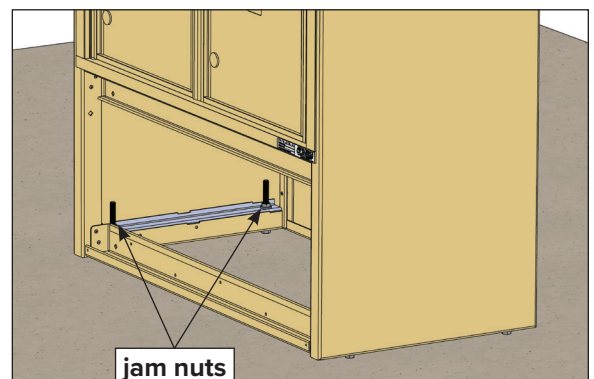

6. Install the two (2) mounting brackets and two (2) skirt plates inside the lower compartment of the 4C Depot cabinet. The skirt plates close the gap beneath the leveled cabinet and the concrete.

- A. Rest the mounting brackets on the concrete pad and position them directly against the side panel structural tubes.
- B. Position the skirt plates between the ends of the mounting brackets and the front and back of the cabinet, and push the plates down against the concrete pad.
 - Be sure both skirt plates are in place before drilling the holes in Step C, to ensure that the mounting brackets are positioned in proper alignment.

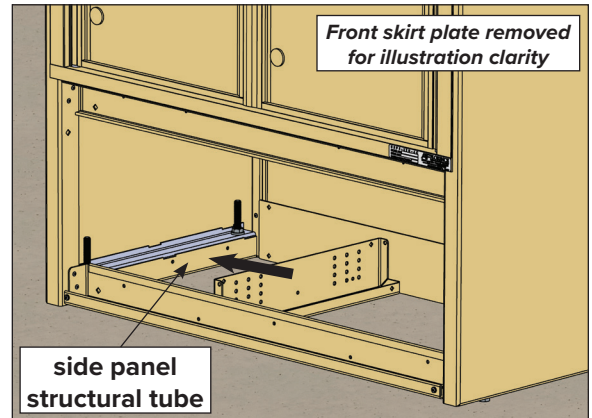

- C. Use the 11/64" diameter drill bit (**206729**) included in the hardware kit (refer to **"HARDWARE LIST" on p. 5**) to drill through six (6) holes in each mounting bracket.
 - Drill the six holes (one in each column of holes) that best align with the side panel structural tube in the side of the cabinet.
 - The holes should only be drilled through the tube wall which is directly against the mounting bracket (approximately 1/4" thick).

Be extremely careful not to drill through the cabinet side panel which is about 1 1/4" from the mounting bracket.

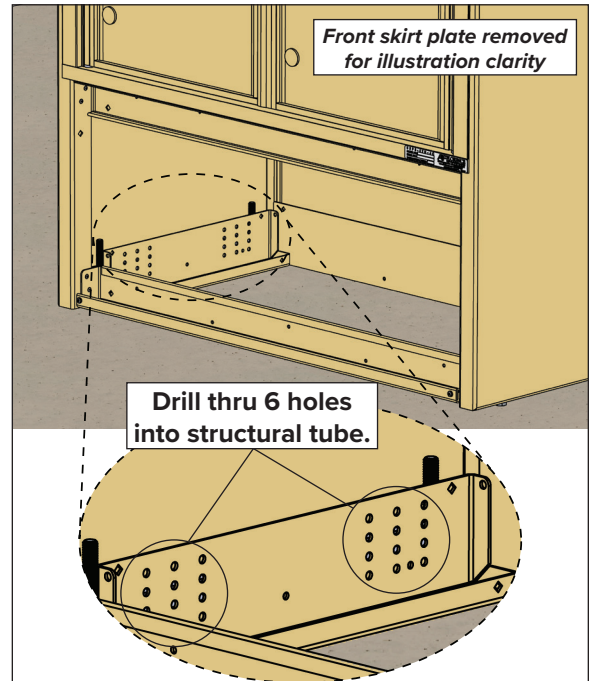

- D. Secure each mounting bracket to the cabinet structural tube using six (6) 10-32 x 1/2" self-tapping Phillips-head screws (206727).

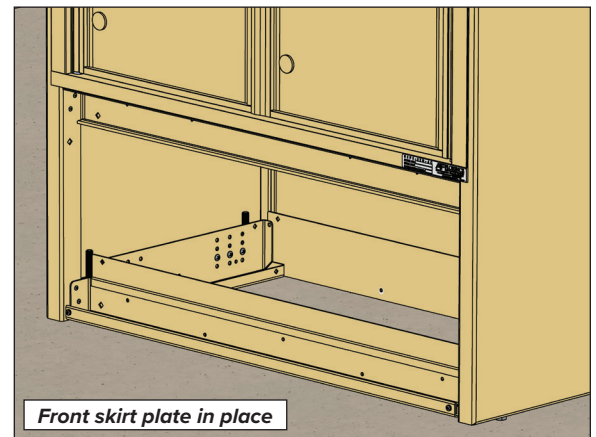
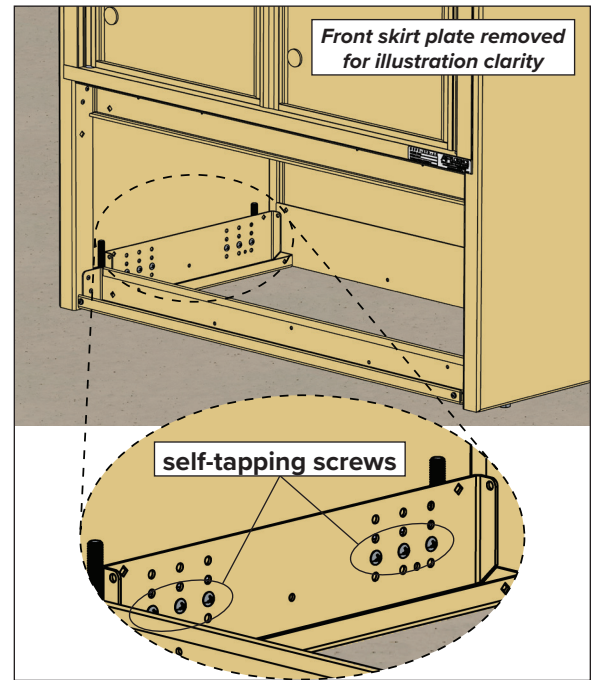

ANCHOR THE 4C DEPOT TO CONCRETE

1. With a hammer drill and 7/16" masonry bit, drill holes through the anchor holes in each end of the mounting brackets to a depth of 4 inches into the concrete.
 - If you successfully drill all four anchor holes to full depth, **go to Step 6.**
 - Otherwise, if you can't apply enough pressure on the drill to completely drill the holes while positioned inside the cabinet, just use the drill to mark the placement of the holes on the concrete and **proceed to Step 2.**

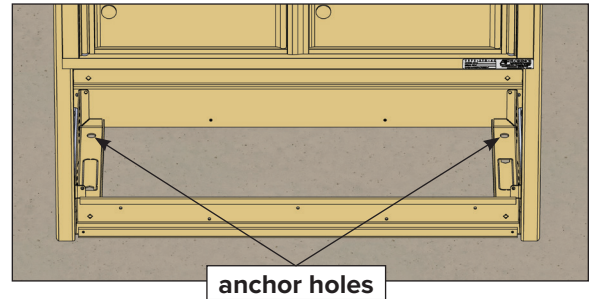

2. Move the cabinet out of the way to reveal the drill marks. Finish each hole in the concrete by drilling to full depth.

3. Move the cabinet back over the holes drilled into the concrete.
 - You only need to align one hole in one of the mounting brackets with the appropriate hole in the concrete.

4. Install a single Tapcon® anchor bolt (206725) with an impact driver and 3/4" socket, but do not tighten all the way.

5. Rotate/pivot the cabinet around the single previously installed anchor until the rest of the holes in the mounting brackets align with the holes drilled in the concrete.

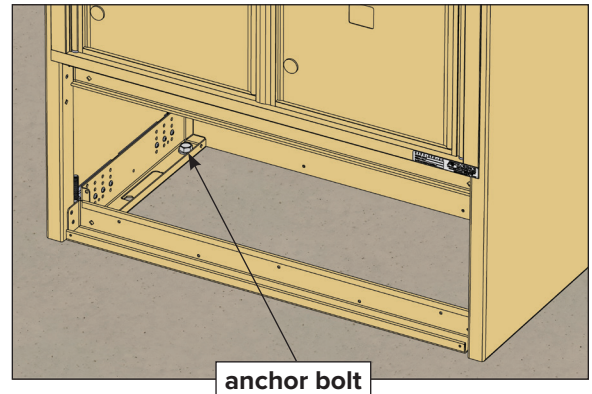

6. Install Tapcon® anchor bolts (206725) into all of the holes with an impact driver and 3/4" socket.

7. Ensure all anchor bolts are tight.

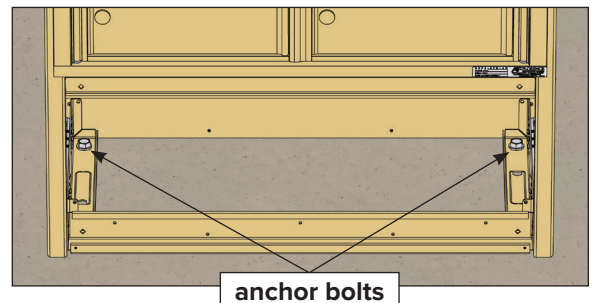

FINISH INSTALLATION

1. Insert the top of the lower-front panel into the gap behind the lower 4C mailbox trim and push the bottom of the panel against the cabinet.

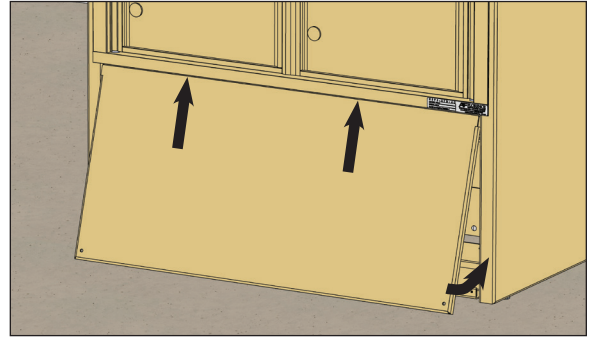

2. Secure the lower-front panel to the cabinet using a #2 square-tip 1/4" hex-shank insert driver bit and the two (2) screws removed at the start of the installation.

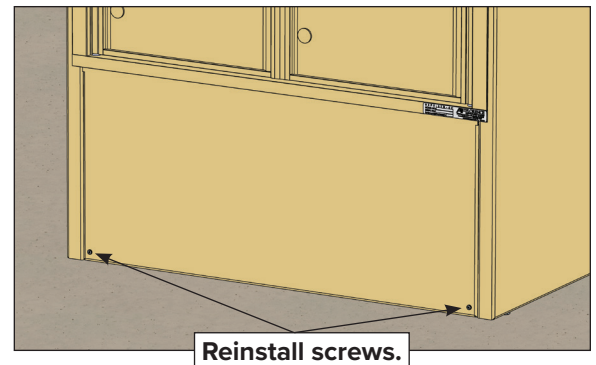

4C MAILBOX ACTIVATION BY USPS

- If the 4C Depot is to be serviced by the US Postal Service, refer to the “**4C Mailbox Installation Manual (206362)**” for specific instructions on Arrow Lock installation to activate service to the mailbox.
- The Arrow lock is installed by USPS Postal Service personnel ONLY.
- Contact your local Post Office to arrange acquisition and installation of the Arrow lock into the master access door, the parcel-door, and the hopper-box collection door. (Collection boxes require a different lock than standard 4C mailbox modules.)

APPENDIX A: INSTALLING 4C MAILBOX INTO DEPOT CABINET

CAUTION

- Florence 4C units are heavy. Use caution when lifting and carrying to avoid injury.
- Pinch hazard exists when placing mailbox units into Depot cabinets. Keep fingers and hands clear to avoid injury.
- 4C Depot with 4C mailbox installed is heavy. Use two (2) or more people to move cabinets. Use caution when lifting and carrying. Failure to do so could result in serious injury. Units must be braced or held in place until secured to the concrete. Failure to do so could result in serious injury.

UNPACK THE 4C DEPOT CABINET

- 1.** Each 4C Depot cabinet will arrive packaged in a single cardboard carton held together by banding.

Be extremely careful not to scratch or damage the finish on the unit when removing the packaging.

- 2.** Cut the banding and carefully remove the packaging from the 4C Depot cabinet.
- 3.** A package containing the hardware needed to install the 4C cabinet, including the mounting screws to mount the 4C mailbox into the 4C Depot cabinet, is taped inside the bottom of the cabinet (refer to **“HARDWARE LIST” on p. 5**).
 - All of the included mounting screws in the **K65734** hardware kit may not be needed, depending on the size of the 4C Depot cabinet.
- 4.** A package containing the 4C cabinet mounting brackets and skirt plates is taped to the inside lower back of the 4C Depot cabinet (refer to **“HARDWARE LIST” on p. 5**).
- 5.** Ensure the leveling feet on the 4C Depot cabinet are adjusted up all the way.
- 6.** Lay the 4C Depot cabinet on its back on a non-abrasive surface which will protect the finish on the cabinet.

- 7.** Insert the 4C mailbox module into the front opening of the 4C Depot cabinet, taking care not to damage the mailbox or the cabinet.

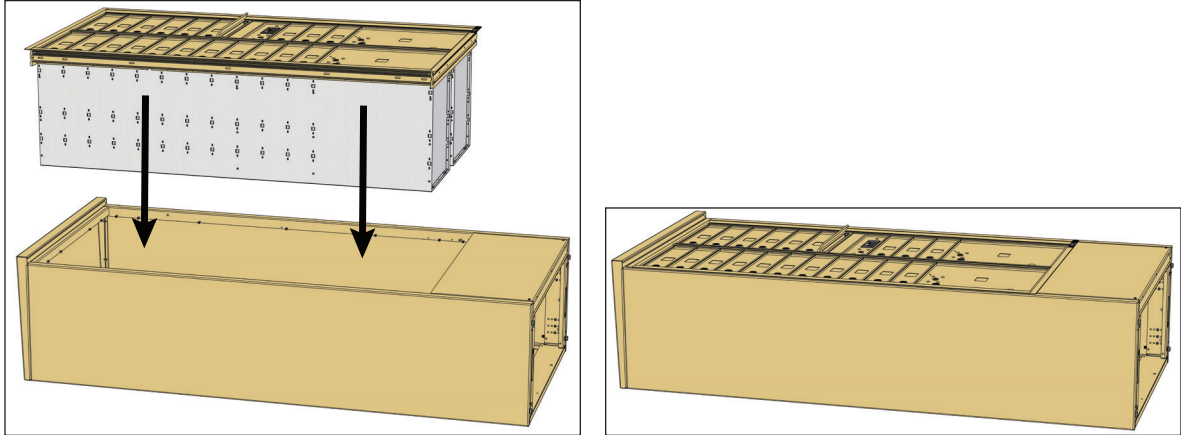

8. For Double-Wide Florence 4C Modules:

- A. Open the right master door until the hold-open arm engages and install the included 8-18 x 1 1/4" pan-head T20 Torx screws (**65734**) in all of the slots along the right-hand outer frame.

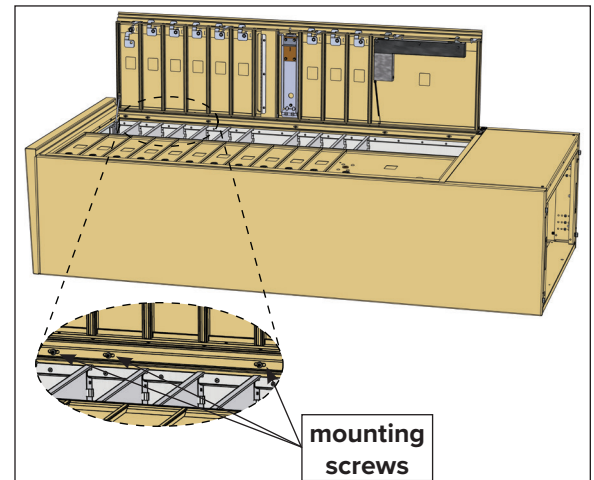

- B. Partially open the left master door until the right master door can be completely closed.
- C. Open the left master door until the hold-open arm engages, and install the included 8-18 x 1 1/4" pan-head T20 Torx screws (**65734**) in all of the slots along the left-hand outer frame.

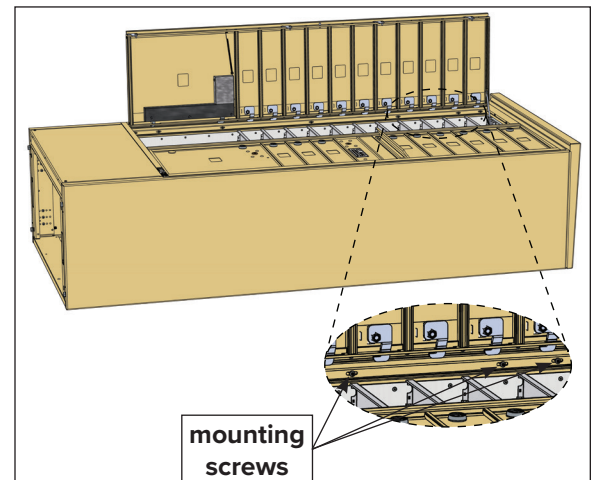

- D. With both the left and right master doors open and hold-open arms engaged, install the included 8-18 x 1 1/4" pan-head T20 Torx screws (**65734**) in all of the holes along the bottom and top frame.

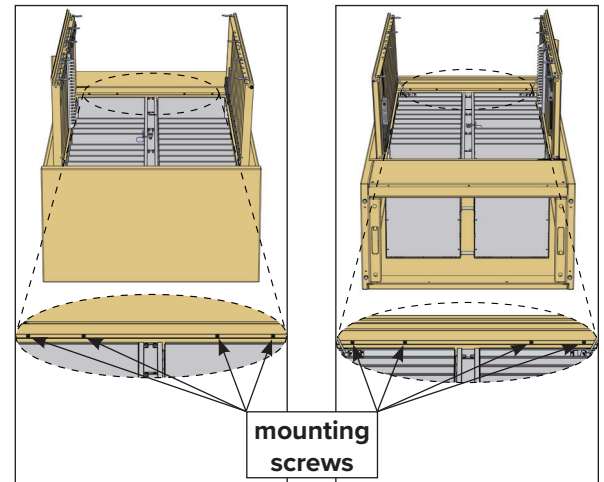

NOTE: The 8-18 x 1 1/4" pan-head T20 Torx screws (65734) should be tightened to ensure a snug fit.

- Overtightening beyond initial contact with the frame could hinder functionality.
- If overtightening occurs, simply back out each overtightened mounting screw.

9. For Single-Wide Florence 4C Modules:

- A. Open the master door until the hold-open arm engages.
- B. Install the included 8-18 x 1 1/4" pan-head T20 Torx screws (**65734**) along both the left- and right-hand outer frame. (Refer to the images in **Steps 7-A** and **7-C** above.)
- C. Install the included 8-18 x 1 1/4" pan-head T20 Torx screws (**65734**) along the top and bottom frame. (Refer to the image in **Step 7-D** above.)

10. Close the master door(s) on the 4C mailbox module.

11. Stand up the 4C Depot with 4C mailbox installed and go to **“PREPARATION AND INITIAL PLACEMENT”** on p. 7 to complete installation of the assembly.

FLORENCE ≡ CORPORATION

5935 Corporate Drive • Manhattan, KS 66503
800 275 1747 • www.florencemailboxes.com



Florence Corporation is part
of the Gibraltar Industries family of companies.
www.gibraltar1.com